



TAMBOUR ELLIS

TAMBOUR ELLIS 3/4 TAMBOUR ELLIS 1/2

Adding architectural profiles to our collection, Tambour. A great way to add warmth, texture and dimension to your space. This is one of two profile size options.

DIMENSIONS

3" w, $\frac{3}{4}$ " radius and 1 $\frac{1}{2}$ " spacing or 3" w, $\frac{1}{2}$ " radius and 2" spacing
Loose 96" sticks long

Six standard panel sizes:

- 18" x 18"
- 18" x 36"
- 36" x 36"
- 18" x 54"
- 18" x 90"
- 24" x 96"

MATERIAL AND SURFACE

Solid White Oak, Eastern Black Walnut, American Beech, American Cherry, Red Alder or CARB-II COMPLIANT/NAUF Medium Density Fiberboard backer

FINISHES / ADHESIVES

Zero VOC waterborne paint
Low VOC waterborne clear coat, 66 g/L
Sheen: Matte 106
Adhesive VOC: 0 g/L
Wood filler VOC: 0 g/L

FIRE RATING

Available in Class A or Class B upon request

SEISMIC RATING

Available upon request

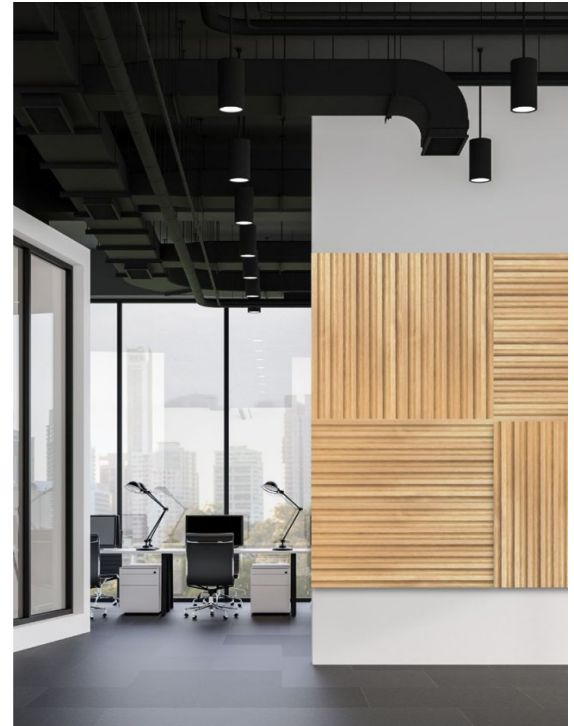

Tambour Ellis 1/2": Red Alder

SAMPLES

Please Contact Us for your request or make your request at windfall.design

LEAD TIME

3-5 weeks depending on area, and ship date provided upon order

MOQ

No Minimum Order Quantity

We are happy to discuss your project for further customization. Please call us or we can join you online to go through your designs.

Contact Us: sales@windfall.design | www.windfall.design



The mark of
responsible forestry
FSC® C041262

TAMBOUR ELLIS

WOOD SPECIES



WHITE OAK

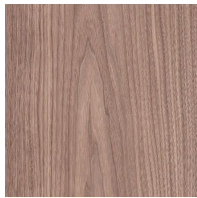

EASTERN BLACK WALNUT



AMERICAN BEECH



AMERICAN CHERRY

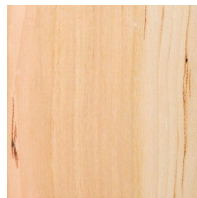

RED ALDER

PAINTED MDF



TRICORN BLACK



SERIOUS GRAY



GRAY MATTERS

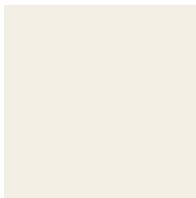

WHITE FLOUR



CUSTOM SW PAINT

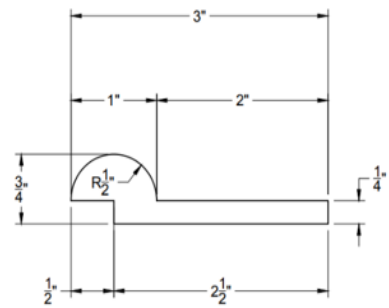
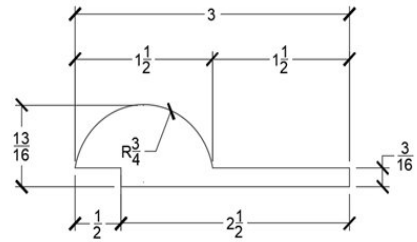

DISCLAIMER: Since wood is a natural material, there are variations, including knots, texture and grain from piece to piece. The wood used may vary from the wood used in samples or product photography due to the inherent characteristics of the material. In turn, no representation, warranty and/or guarantee is made with respect to the precise color, luster or appearance of finishes.

Tambour Ellis INSTALLATION METHODS

STICKS

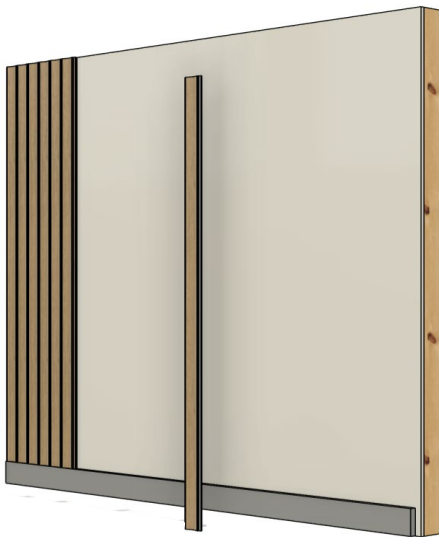

Tongue + groove cladding
(loose sticks) Traditional install
with nails + adhesive

PANELS

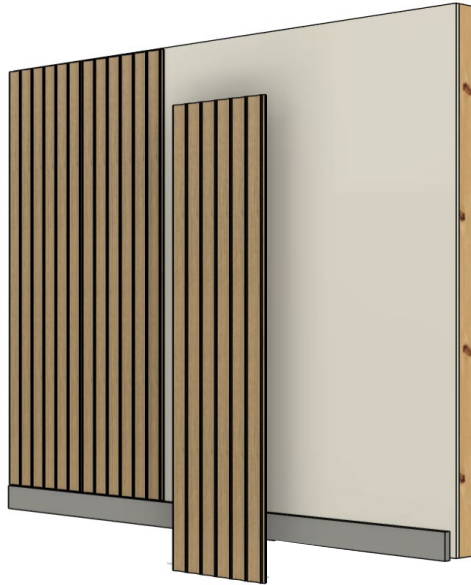

Panels installed using
fixed mounted fastener

CAMBIO PANELS



Cambio by Windfall panels
Installed with patented
magnetic wall system.

DESIGN YOUR WALL

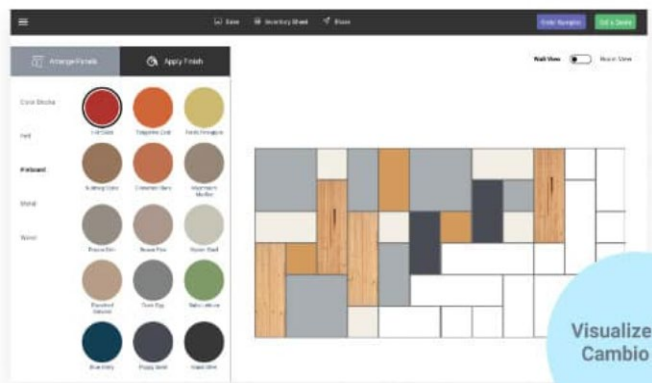

USE OUR VISUALIZER TOOL TO DESIGN
YOUR WALL. RECEIVE AN INVENTORY LIST,
SEND TO OUR TEAM FOR A QUOTE.